

Model 211

Announcer's Console

User Guide

Issue 1, December 2015

This User Guide is applicable for serial numbers:
M211-00151 and later

Copyright © 2015 by Studio Technologies, Inc., all rights reserved

www.studio-tech.com

This page intentionally left blank.

Table of Contents

Revision History.....	4
Introduction.....	5
System Features	5
Installation and Setup.....	9
Configuration	13
Operation.....	21
Technical Notes	24
Specifications	29
Appendix A	30
Appendix B	31
Block Diagram	

Revision History

Issue 1, December 2015:

1. Initial release.

Introduction

What This User Guide Covers

This User Guide is designed to assist you when installing, configuring, and using Model 211 Announcer's Consoles with serial numbers 00151 and later. Additional background technical information is also provided. A product block diagram is included at the end of this guide.

System Overview

The Model 211 Announcer's Console is designed to serve as the audio control center for announcers, commentators, and production talent. The tabletop unit is suited for numerous applications including on-air television sports broadcasting. The Model 211 integrates all on-air, talkback, and cue audio signal routing into one compact system. Ease of use, configuration flexibility, and sonic excellence are some of the unit's highlights.

The Model 211 is compatible with many broadcast and audio system environments. Standard connectors are used to interface microphone, headphone, talkback, and talent cue signals. Whether it's microphone switching, talkback output, or headphone cue feed, superior audio quality is maintained. A microprocessor provides the Model 211's logic power, allowing exacting control of the unit's operation. A range of configuration choices allow the desired operating parameters to be easily selected. While flexible, the user is presented with an easy-to-use set of controls and indicators.

A truly next-generation product, extensive research into the needs and desires of field production personnel was integral to the Model 211's creation. Target applications include on-air television, radio, streaming,



Figure 1. Model 211 front and back views

and production applications. Specialized features are included to allow the Model 211 to be used in a variety of other audio applications. These include stadium announcement and voice-over/narration booths.

System Features

Microphone Input

A high-performance microphone preamplifier circuit provides low-noise/low-distortion amplification over a 20 to 60 dB gain range. The gain is adjustable in 10 dB steps. The input is compatible with balanced dynamic

or condenser-type microphones. The microphone power source meets the worldwide P48 phantom power standard. The preamplifier's gain can also be set for 0 dB, allowing a line-level audio signal to be connected. This could prove useful in special applications such as when an external preamp or mic processor is being used. An LED indicator serves as an aid for optimizing the setting of the preamplifier's gain. The output of the microphone preamplifier is used by the main output as well as being routed to the compressor circuit that supports the talkback function.

Main and Talkback Outputs

The Model 211 provides one main and one talkback output. The main output is designed to serve as the on-air, stadium announcement, or other primary audio feed. With a nominal level of -2 dBu, it is designed as a fully professional interface with high output capability, low distortion, and low noise. It features a high-quality transformer expressly designed for driving long broadcast cable runs. The talkback output is intended to provide production trucks, control rooms, or support personnel with a talent-originated cue signal. The talkback output is transformer-coupled with a $+4$ dBu nominal signal level. It contains resistors in series with its output connections, allowing the talkback output from multiple units to be directly summed (combined).

For non-on-air applications, a special Model 211 feature can be enabled, placing the unit in a "production" mode. This allows the main output to be used as a second talkback output. In this configuration the unit can be even more powerful when used in a live-event application, such as serving as a master console for a production director.

Dynamic Range Control

A studio-quality compressor circuit is provided to control the dynamic range of the signal coming from the microphone preamplifier. Far from a simple "clipper," the circuit utilizes a sophisticated laser-trimmed voltage-controlled-amplifier (VCA) integrated circuit for quiet, low-distortion level control. The signal from the compressor is always used by the talkback output. In addition, the audio source for the main output can be selected to be either the output of the microphone preamplifier or the output of the compressor. While possibly inappropriate for major on-air situations, having dynamic range control of the main output can offer increased effectiveness for many applications. These could include stadium announcement positions, sports events using non-professional on-air talent, and situations where cable crosstalk is of concern.

User Controls and Status Indicators

Two pushbutton switches, three LED indicators, and two rotary controls provide the user with a clear, easy-to-use interface. One pushbutton switch controls the status of the main output. This is the audio output intended for on-air, announcement, or other primary uses. Two LEDs display the on/off status of the main output. A second pushbutton switch controls the status of the talkback output. This is the audio output used to communicate with producers, directors, spotters, or other behind-the-scenes production personnel. A status LED is associated with the talkback button. Two rotary controls allow the user to adjust the level of the headphone output.

Flexibility

A large part of the Model 211's unique power is the ability to configure the operation of the main output and talkback functions. To meet the needs of the many specific broadcast and production applications, a variety of button operating modes is available. The main output button can be selected to operate from among four modes. In the "push-to-mute" mode the button performs a momentary mute of the main output. In this way a "cough" button function is created, something typically required for television sports broadcasting. In the "push-to-talk" mode the button provides a momentary active function for the main output. This mode would be appropriate for applications such as stadium announcement. An alternate action "latching" configuration allows the button to enable or disable the main output as desired. This is useful in radio broadcasting, announce-booth, or voice-over applications. The fourth mode provides a hybrid function, supporting both push-to-talk and tap-to-enable/tap-to-disable operation. This operation is similar to that found in many broadcast intercom system user stations.

The button associated with the talkback function can be configured to operate from either of two modes. One of the modes supports a "push-to-talk" function. This is typically used for on-air broadcast applications. The other mode provides a hybrid function, the operation of which is discussed in the previous paragraph. The hybrid mode is especially useful when the Model 211 is used in a production-support application.

Cue Sources

Two line-level audio sources can also be connected to the Model 211. Possible signal sources include audio consoles, matrix intercom systems, and off-air receivers. The connected signals can be from two independent sources or could be a stereo audio feed such as would be associated with a broadcast music event. Two trim potentiometers, located on the bottom of the unit, allow signals with wide nominal audio levels to be cleanly interfaced. Each source can be individually assigned to the left channel, right channel, or both left and right channels of the headphone output. This allows a wide variety of stereo and mono headphone mixes to be created.

Using the optional IFB Input Card Kit broadcast-standard 2-channel powered ("wet") IFB circuits can also be connected to the Model 211. In this way an IFB ("interruptible foldback") audio signal can be used as a source of headphone cue audio signals. (But note that the connected IFB circuit will not be able to power the Model 211; only the audio signals will be interfaced!) The two audio signals associated with the IFB input can be assigned to either or both of the headphone output channels. Originating in production trailers, control rooms, or remote locations, an IFB source typically provides DC power and program-with-interrupt audio on one channel and program-only audio on the other.

The IFB Input Card Kit also allows direct connection to single- and dual-channel party-line (PL) intercom circuits. This can be useful when applications will benefit from intercom audio channels being used for headphone cue signals. But be aware that no talkback into the PL circuits is possible, nor is it possible to power the Model 211 from the party-line circuit.

Headphone Output

Two rotary controls are provided for user adjustment of the headphone output levels. For application flexibility the actual function of the two “pots” is configurable. For traditional on-air sports applications they can be selected to the dual-channel (“level/level”) mode which provides independent control of the left- and right-channel volume. For use with dual-channel cue signals, or to support user preference, the stereo (“level/balance”) mode can be selected. In this mode one control adjusts the overall level of both the left and right channels, while the other allows adjustment of the left/right level balance. To help minimize the chance of broadcast cues being missed, both level control modes can be configured so that a minimum headphone output level is maintained. Alternately, the headphone output can be set to fully mute when the controls are at their minimum position.

Provision has been made to support applications where a monaural cue feed is desired. A configuration switch allows the summing (combining) of the selected left and right headphone sources. In addition to creating a dual-channel mono output it also allows the level controls to be configured as a simple 2-channel mixer.

The headphone output was designed to meet the needs of contemporary headphones and headsets. Specifically, the output circuits act as voltage, rather than power, drivers. In this configuration they can provide high output levels with very low distortion and noise, along with minimal current consumption. The output circuits are configured to safely drive stereo or mono loads. This ensures that all types of headphones, headsets, and earpieces can be directly connected.

Audio Quality and Protection

The Model 211’s circuitry is carefully tailored to provide excellent audio performance. Professional-quality components are featured throughout. For reliability all audio routing is performed using solid-state devices. In all critical audio paths, “clickless” electronic switches provide noise-free control. All audio inputs and outputs make extensive use of protection components. This limits the chance of damage from ESD and other undesirable, yet real-world, hazards.

Power Source

The Model 211 derives its operating power from an external nominal 24 volt DC source. Internal switch-mode power supply circuitry uses the incoming 24 volt source to generate the various voltages required by the Model 211’s circuitry, including P48 phantom. A universal input/24 volt DC external power supply is included with each Model 211 unit.

Relay Contacts

The Model 211’s circuitry includes two general-purpose relay contacts to allow specialized configurations to be created. Under software control, the form-A (normally open) solid-state relay contacts follow the state of the main and talkback output functions. Taking advantage of the locations provided for additional XLR connectors, a technician may easily implement a variety of functions such as a mic active indication, audio muting during talkback, or audio insertion control.

Configuration

Model 211 configurations are made using a number of DIP switches. One 8-position switch assembly is used to set the gain of

the microphone preamplifier, the on/off status of phantom power, and the headphone stereo/mono mode. A second 8-position switch assembly configures which of the line-input and optional auxiliary input audio sources are routed to the headphone output. A third 8-position switch assembly communicates the desired operating modes to the microprocessor. All switches are accessible via the bottom of the Model 211's enclosure; the unit does not have to be disassembled. Changes made to any of the configuration parameters become active immediately. To prevent unwanted access to the configuration switches a security plate, included with each unit, is attached to the bottom of the enclosure.

Connectors

The Model 211 uses standard connectors throughout. The microphone and line-level inputs use 3-pin female XLR connectors. The main and talkback outputs use 3-pin male XLRs. A ¼-inch 3-conductor jack is used for the headphone output. The external source of 24 volt DC power is connected by way of a 2.1 x 5.5 mm "locking" coaxial power jack.

In the world of broadcast and production audio it's fair to say that applications vary widely. To this end, one or two additional XLR connectors can easily be mounted into the Model 211's back panel. Multiple 3-position headers located on the Model 211's circuit board provide technician access to all input and output connections. Using a factory-available interface cable kit allows a Model 211 to be optimized to meet the exact needs of specific applications. For example, some applications may prefer to use a multi-pin XLR connector to interface with a headset. This can easily be

accomplished by adding the appropriate 5-, 6-, or 7-pin XLR connector and making a few simple connections. Other applications may benefit from having "mult" or "loop-through" connections, something easily incorporated into a Model 211. An optional IFB input card, as previously discussed, can also be mounted in one of the spare XLR connector positions.

200-Series Announcer Console Products

The Model 211 is just one in a series of announcer console products available from Studio Technologies. For applications that require an alternate set of features the other products in the 200-Series should be reviewed. Complete information is available on the Studio Technologies website.

Installation and Setup

In this section interconnections will be made using the input and output connectors located on the Model 211's back panel. Microphone, cue audio, main output, and talkback output signals are interfaced by way of 3-pin XLR connectors. A ¼-inch 3-conductor phone jack is provided for the headphone output. A 2.1 x 5.5 mm coaxial jack allows connection of an external 24 volt DC power source.

System Components

Included in the shipping carton are the following: Model 211 Announcer's Console, user guide, button label sheet, and 24 volt DC power supply.

Microphone Input

The Model 211 is compatible with balanced dynamic and condenser microphones. Depending on the application, the microphone may be part of a headset, or be an independent handheld or stand-mounted model. The Model 211's P48 power source will support essentially all phantom-powered microphones. The quality of the Model 211's microphone preamplifier and associated circuitry is such that special applications may benefit from using "high-end" microphones. If selected appropriately, models from manufacturers such as AKG, Beyerdynamic, DPA, Neumann, Sennheiser, and Shure will perform very well in Model 211 applications.

Microphone interconnection is made by way of a 3-pin female XLR connector which is located on the Model 211's back panel. The mating connector (male) should be wired so that pin 2 is signal high (+ or hot), pin 3 is signal low (– or cold), and pin 1 is shield. It's possible that an unbalanced microphone will also work correctly. In this case, the mating connector (male) should be wired so that pin 2 is signal high (+ or hot), and signal common/shield is connected to both pins 1 and 3.

As of the writing date of this user guide, the Sennheiser HMD 26 headset is very popular for on-air sports broadcasting use. A fine product, it works very well with the Model 211. Note that adding the suffix "-XQ" to the headset's full part number (HMD 26-600-XQ) specifies a 3-pin male XLR connector for the dynamic microphone and a ¼-inch 3-conductor plug for the stereo headphones. This configuration is very useful, allowing the headset to work directly "out of the box" with the Model 211.

If the writer may digress for a moment to recount a story... an audio dealer once shared a secret with me concerning headsets. He loved selling the "lower-end" (less expensive) models of name-brand headsets, which he did by the veritable "boatload." Why? Because these usually broke soon after going into service! He knew that on a regular basis he'd receive orders for more of them. Had these users, from the beginning, purchased only premium-quality headsets, their total cost of ownership would have been much less. Enough said...

Headphone Output

The Model 211's headphone output is compatible with stereo or mono headphones, headsets, or earpieces. Connecting devices with a nominal impedance of 100 ohms or greater is preferred. This shouldn't be an issue as essentially all contemporary devices meet this condition.

Devices are connected to the headphone output by way of a ¼-inch 3-conductor phone jack located on the Model 211's back panel. As is standard for stereo headphones, the left channel is connected to the "tip" lead of the ¼-inch headphone jack. The right channel is connected to the "ring" lead of the jack. Common for both channels is connected to the "sleeve" lead.

Devices with ¼-inch 2-conductor "monaural" plugs can also be used with the Model 211's headphone output. In this arrangement only the tip lead (left channel) will be active. The 2-conductor plug will physically connect ("short") the ring lead (right channel) to the sleeve lead (common). Technically this won't damage the circuitry associated with the right-channel headphone output since 100 ohm protection resistors are electrically in series with the headphone output circuits.

Main Output

The main output is intended to be the “on-air” signal that connects to the input of an audio console. The output is transformer balanced with a nominal signal level of –2 dBu. The actual level will depend on the gain setting of the microphone preamplifier, sensitivity of the microphone, and how loudly the talent speaks into the microphone. The transformer used in the main output is intended for professional broadcast applications. It has a low output impedance and can drive lengthy cable runs with no difficulty. It is capable of driving 600 ohm loads but performs best with loads of 2 k ohms or greater. (This should not prove to be an issue as virtually all contemporary audio equipment has a relatively high input impedance.) As the secondary winding of the output transformer connects directly to the main output connector, care should be taken so that DC voltage is never present on the interconnecting cable.

The main output is interfaced by means of a 3-pin male XLR connector located on the Model 211's back panel. The interconnecting cable's mating connector (female) should be wired so that signal high (+ or hot) is on pin 2 and signal low (– or cold) is on pin 3. The cable's shield can be connected to pin 1, but it will have no function. To limit the chance of grounding interaction between the Model 211 and connected equipment, pin 1 on the main output's connector is isolated from any point in the Model 211. The fact that pin 1 “floats” will minimize the chance of hums, noises, or buzzes being present on the equipment connected to the main output.

Talkback Output

The talkback output is intended for connection to control rooms, production trailers,

or other locations where talent- originated voice cues are required. The talkback output is transformer balanced with a nominal level of +4 dBu. To enhance talkback audio quality, the compressor circuit controls the dynamic range of the signal coming from the microphone preamplifier.

For protection against accidental connection to cables that have DC power present, the talkback output is capacitor coupled. Also in series with the talkback output connections are 300 ohm resistors, making the effective output impedance approximately 600 ohms. These resistors create a passive summing network, allowing talkback outputs on multiple Model 211 units to be connected together.

The talkback output is connected by way of a 3-pin male XLR connector which is located on the Model 211's back panel. A mating connector (female) should be prepared so that signal high (+ or hot) is expected on pin 2. Signal low (– or cold) should be expected on pin 3. The cable's shield can be connected to pin 1. But, as with the main output, in order to minimize the chance that ground-interaction problems will arise, pin 1 of the talkback output connector is isolated from the Model 211's chassis and circuitry. By making pin 1 “float,” the often-feared “ground loop” problem shouldn't arise.

The talkback output is intended to drive lengthy cable runs that are frequently part of a remote broadcast application. While the talkback output circuitry is not intended to be “on-air” quality, overall audio performance should be very good. Devices connected to the talkback output include amplified loudspeakers, analog inputs on intercom systems, and input channels associated with audio consoles. Connecting

the talkback output to devices that allow easy control of the signal level can be helpful. For example, connecting to a spare input channel on an audio console will provide the flexibility to add gain or attenuate as required. A talkback-associated output connection on the audio console can then connect to the final destination(s).

As previously mentioned, the talkback outputs on multiple Model 211 units can be directly connected together. Using a simple “Y” or “W” cable, this passive summing (adding together) of talkback signals allows one audio cable to serve as a master talkback path. A side effect when using this passive summing technique is that signal attenuation will occur. The audio quality won't suffer appreciably, but an audio “pad” is created. If two talkback outputs are connected together, a signal attenuation of 6 dB can be expected. Connecting three talkback outputs together will result in 9.5 dB of attenuation. And four talkback outputs “malted” together will lead to 12 dB of attenuation. In most cases this attenuation won't pose a problem. Typically a device that receives the talkback signal, such as an amplified loudspeaker, will have a method of adjusting its input sensitivity.

Line Inputs

The Model 211 allows two line-level audio sources to be connected. These sources can be individually routed to the left channel, right channel, or both the left and right channel of the headphone outputs. The inputs are balanced, transformer-coupled with a nominal impedance of 10 k ohms. Capacitors, in series with the transformer's input leads, prevent a DC voltage present on a connected source from impacting performance. The line inputs are compatible with signals that have a nominal level

of -12 dBV to $+6$ dBu. Two trim potentiometers, located on the bottom of the Model 211's enclosure, allow signals over this wide nominal level range to be effectively utilized. Audio sources are connected to the line inputs by way of 3-pin female XLR connectors which are located on the unit's back panel. Prepare the mating connectors (males) so that pin 2 is signal high (+ or hot), pin 3 is low (– or cold), and pin 1 is shield. If connecting a source in this manner results in hum or noise, it's possible that removing the shield connection from pin 1 can eliminate the issue. With an unbalanced source connect pin 2 to signal high (+ or hot) and both pins 1 and 3 to shield. If connecting an unbalanced source in this manner results in hum or noise, connect pin 2 to high (+ or hot) and pin 3 to shield; leave pin 1 not terminated

DC Power Input

An external source of nominally 24 volt DC power must be connected to the Model 211 by way of a 2.1 x 5.5 mm coaxial power jack which is located on the back panel of the unit. The center pin of the jack is the positive (+) connection. While the requirement for the external source is nominally 24 volts, correct operation will take place over a 20 to 30 volt range. The Model 211 requires 70 milliamperes at 24 volts DC for correct operation.

Included with each Model 211 is a 24 volt DC external power supply. The power supply's DC output cable has been terminated with a Switchcraft® S760K coaxial power plug. This “locking” type of plug correctly mates with the Model 211's 24 volt DC input jack. The locking feature is important, allowing the external power source to be securely attached to the Model 211.

Pushbutton Labeling

The two pushbutton switches used in the Model 211 were selected for several reasons. Foremost was the fact that they are highly reliable, using gold-plated contacts for long life in less-than-ideal environments. A second reason was that applying customized labels to the button caps would be very simple. The labels, text printed on clear material, are placed under the clear caps on the top of the buttons.

From the factory the left button is labeled COUGH and the right button is labeled TALKBACK. This was selected to be appropriate for many on-air applications in English-speaking locations. But it's expected that these may need to be changed to meet the needs of specific applications.

As a "head start" for some applications, a clear sheet with a number of commonly used English-language button designations printed on it is included in the shipping carton. These were created at the factory using a standard personal computer graphics program and laser printed onto 3M CG3300 or equivalent transparency film. The desired button labels can be cut out with a pair of scissors or an X-ACTO® knife following the printed guide lines that indicate the required size.

The clear lens on top of each button cap can be removed with a fingernail or small screwdriver. Be certain not to scratch the button if a screwdriver or other small tool is used. The clear label can be removed and replaced. The button cap is then snapped back into the top of the button housing using finger-pressure only. No tool is required to replace the button cap.

If you need to make your own labels the process is quite simple. Use a personal computer to create the desired text. The

finished label size should be 0.625-inches (15.8 mm) square. The completed artwork can then be printed on transparency film sheets using a laser or inkjet printer. These sheets are readily available from most office supply stores. A pair of scissors or an X-ACTO knife will complete the task.

Configuration

For the Model 211 to support the needs of specific applications a number of operating parameters must be configured. These include microphone preamplifier gain, phantom power on/off, headphone source selection, headphone stereo/mono mode, and operating modes. Three 8-position DIP switch assemblies are used to establish the desired configuration. These switch assemblies are referred to as SW1, SW2, and SW3, with individual switches designated as SW1-1, SW1-2, etc. The switch assemblies are accessed through openings in the bottom of the Model 211's enclosure. The enclosure does not have to be disassembled to gain access to the switches.

To prevent unauthorized personnel from changing the configuration settings, a security plate is attached to the bottom of the Model 211's enclosure. For convenience, the security plate provides a summary of the configurable parameters and related information. Refer to Appendix A for a representative view. The security plate is held in place by means of four rubber bumpers ("feet") that have built-in screws. Using your fingers, remove the four bumpers so that the plate can be removed. Refer to Figure 2 for a detailed view of the configuration switch assemblies.

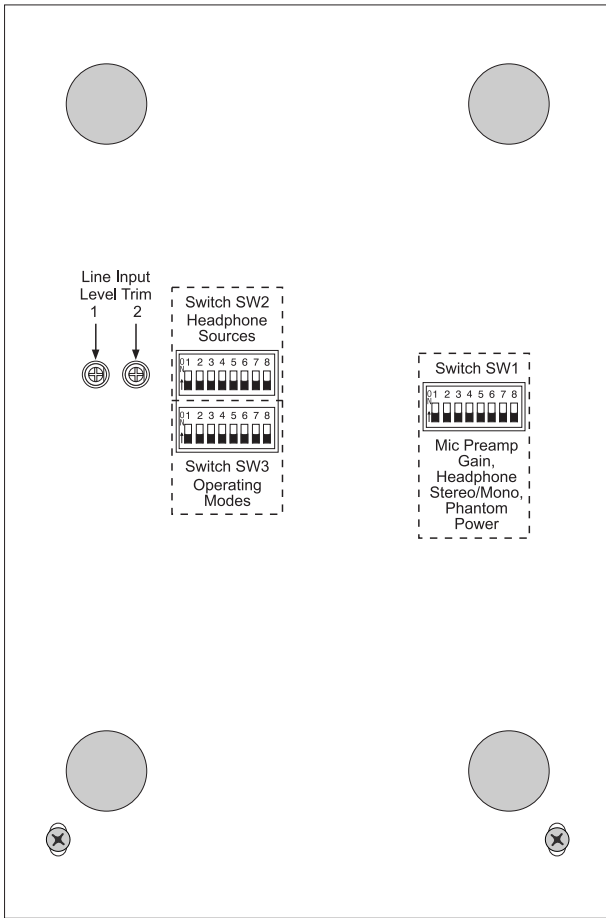

Figure 2. Bottom view of Model 211 showing configuration switches and trim pots

Microphone Preamplifier Gain and Phantom Power

Five switches are used to set the gain of the microphone preamplifier. One switch is used to select the on/off status of the phantom power supply.

Microphone Preamplifier Gain

Switches SW1-1 through SW1-5 are used to select the gain of the microphone preamplifier. The choices are 20, 30, 40, 50, and 60 dB; 0 dB (no gain) is also available. Only one switch should be enabled at a time. There's no problem changing the gain setting while the unit is operating. Audio clicks or pops might occur during gain transitions, but this shouldn't be a major issue

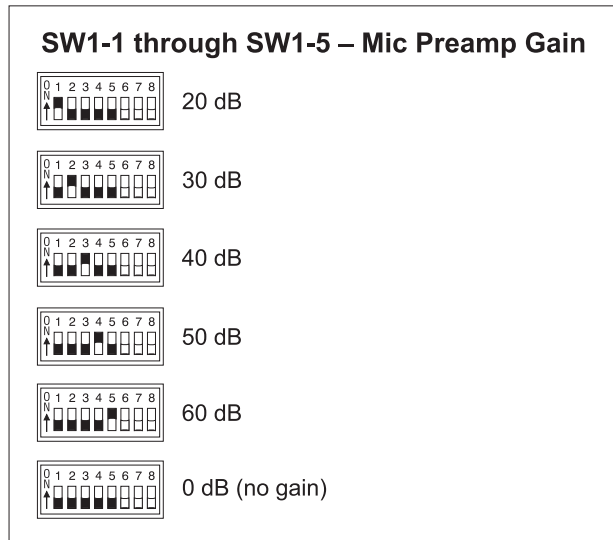

Figure 3. Microphone preamplifier gain switch settings

as long as associated monitor loudspeakers are temporarily attenuated or muted.

Selecting the correct amount of gain for an application might take a little experimentation. The goal is to bring the mic's signal up to line level, nominally -2 dBu for the Model 211's main output. Operating at this signal level will help to ensure the delivery of "clean" audio to the connected device. It's also acceptable to connect a line-level audio source to the microphone input. In this case selecting 0 dB (no gain) would be appropriate.

The output of the Model 211's microphone preamplifier is used by the main output and, by way of the compressor circuit, the talk-back output. So creating a nice "hot" signal will help to maintain the audio quality, specifically a high signal-to-noise ratio, when driving lengthy cable runs.

Unfortunately, there's no "perfect" gain setting that this guide can recommend. The two issues that impact the setting are output sensitivity of the connected microphone and the acoustical output level of

the microphone's user. With some headset microphones, such as the Sennheiser HMD 26, selecting an initial setting of 40 dB is appropriate. Users who speak loudly might need to have the gain reduced to 30 dB. Quiet users might need 50 dB of gain.

An LED indicator is provided as an aid in correctly setting the gain of the microphone preamplifier. Red in color, this LED is located on the back panel adjacent to the mic input connector and is labeled COMP. Technically, this red LED lights whenever the compressor circuitry is controlling the dynamic range of the signal coming from the microphone preamplifier. The threshold is set to be 2 dB above the Model 211's nominal internal operating level. So a good "rule of thumb" is to adjust the gain of the microphone preamplifier such that the compressor active LED lights ("flashes") when the connected microphone is sending signal peaks. During normal operation the LED should not remain fully lit when audio is present on the mic input.

It's important to remember that the compressor active LED is used to assist in setting the gain to the optimal value. It doesn't necessarily indicate that the main output's signal is being compressed. Unless specifically configured to perform otherwise, the output of the compressor is only used for the talkback output.

It's expected that the 20 and 60 dB gain settings will not often be used. But there are always exceptions and that's why they were included. It's possible that with a very "hot" microphone, such as a phantom-powered condenser, 20 dB of gain could be correct. It's also possible that a microphone with a very low-level output, such as a ribbon-type, would need 60 dB of gain. But in general, the 30, 40, and 50 dB gain settings will serve most applications.

Note that if no gain switch is set to its active (on) position the preamplifier will operate at unity (0 dB) gain. This is provided for compatibility when line-level signals need to be connected to the microphone input. However with a microphone connected as the input source the 0 dB setting should never be used. The issue is that with no gain added to the microphone input signal, the relative noise floor on the main and talkback outputs will be much too high.

Phantom Power On/Off

The Model 211 can provide P48 phantom power to the connected microphone. Switch SW1-8 controls whether or not phantom power is active. By phantom power's very nature it could be left applied to the microphone input at all times. But generally people prefer to turn it off unless required for a specific microphone.

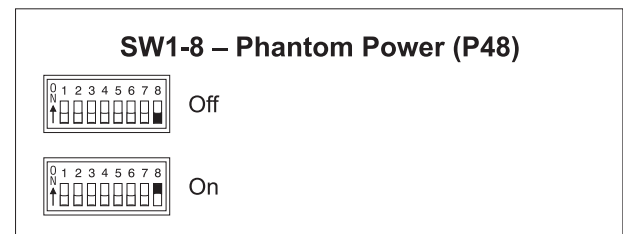

Figure 4. Phantom power switch settings

Headphone Source Selection

Switch assembly SW2 is used to configure the source or sources that are routed to the stereo headphone output. The headphone sources are line input 1, line input 2, auxiliary input 1, and auxiliary input 2. The line inputs are provided by way of the XLR connectors located on the Model 211's back panel. The auxiliary inputs are available on the Model 211's main circuit board and are only accessible if an optional IFB input card has been installed or a special Model 211 configuration has been implemented.

Each of the available input sources can be assigned to the headphone output's left channel, right channel, or both the left and right channels. The Model 211's circuitry allows any combination of input assignments to be made.

Note that in some cases a user may wish to wear a headset or a pair of headphones in a left/right orientation opposite of what is usual. In this situation the transducer designated for the left ear would actually supply audio to the user's right ear, and vice versa. A specific application when this occurs is where on-air talent needs to have a headset's boom microphone come across the right side of their face, rather than the more-typical left side. In this case it's important to select the left- and right-channel headphone source assignment accordingly. With the Model 211's flexible source selection there's

no reason why users, such as on-air talent, shouldn't have their cue sources assigned correctly.

There may be cases where a monaural "single-muff" headset or headphone will be connected to the Model 211's headphone output. In this case the desired source(s) should be routed only to the left channel. No sources should be assigned to the right channel. This will eliminate the short-circuit current that could occur when a 2-conductor (monaural) plug is mated with the Model 211's 3-conductor (stereo) headphone output jack.

Headphone Output Mode

Switch SW1-6 allows a monaural headphone output to be created. This is accomplished by summing (adding) the selected left- and right-channel cue signals. The combined signals are sent to both the left- and right-channel headphone output driver circuits. The outputs of these circuits connect, by way of 100 ohm series protection resistors, to the headphone output jack.

The headphone output monaural mode feature was specifically included so that a special 2-channel headphone mix mode can be created. By enabling the mono mode, the two front-panel user level controls ("pots") can be used to create the desired "mix" of signals being sent to the headphone output. Many applications, especially in production settings, can benefit from this capability. The desired cue sources must be carefully assigned to take advantage of the monaural mode. The first cue source should be assigned, using the appropriate configuration switch, to the left channel. Its output level will be adjusted by the left control. The second cue source should be assigned to the right channel. Its output level will be adjusted by the right control.

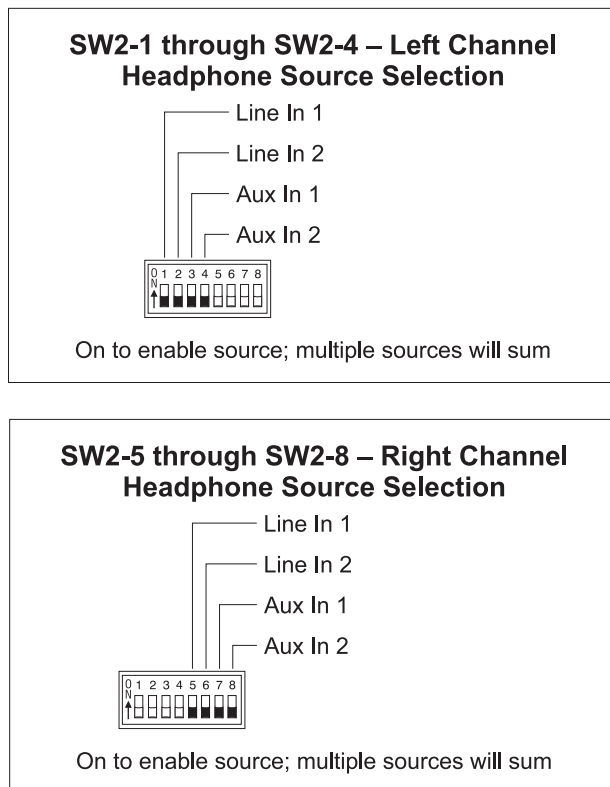

Figure 5. Left and right channel headphone source selection settings

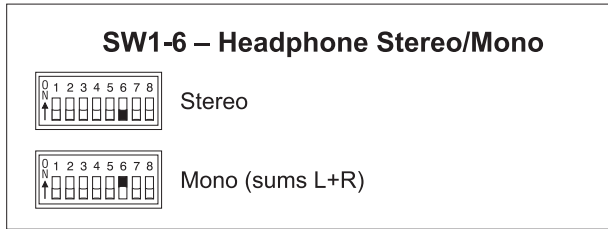

Figure 6. Headphone output mode settings

There is one limitation related to the headphone mono output mode. It's the fact that the output will be 2-channel monaural. Whatever signal is present on the headphone output's left channel will also be present on the right channel. A stereo headphone mix can't be created. But in most cases this limitation won't overshadow the benefit of being able to create the mix. For signal-flow clarification please review the block diagram located at the end of this user guide.

Operating Modes

The eight switches associated with switch assembly SW3 are used to configure the Model 211's operating modes. Technically, these switches "talk" to the microcontroller integrated circuit and associated software that give the Model 211 its "smarts." The software has been carefully designed to provide a number of different ways in which the unit can function. It's critical to carefully review the available options and choose the ones that best meet the needs of a specific application. Note that switches can be changed even while the Model 211 is powered up and operating. The unit's operating characteristics will change in "real-time" in response to configuration changes.

Main Output Button Mode

Switches SW3-1 and SW3-2 configure how the main output button functions.

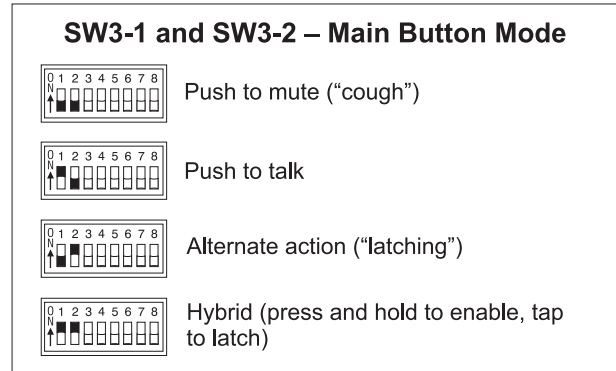

Figure 7. Main output button mode settings

There are four available modes:

- **Push to mute:** In this mode the main output is normally active. The main output will mute whenever the button is pressed and held. This is the "cough" mode typically used for on-air sports broadcasting applications.
- **Push to talk:** In this mode the main output is normally muted. The main output will become active whenever the button is pressed and held.
- **Alternate action:** In this mode the main output will change between its active and muted state whenever the button is pressed. Upon power up the main output will be in its muted state.
- **Hybrid:** This mode is a combination of push to talk and alternate action. It's similar to the way talk buttons function on user stations associated with broadcast and production intercom systems. If the button is pressed and held, the main output will become active until the button is released. If the button is momentarily "tapped" the main output will change state. Upon power up the main output will be in its muted state.

Talkback Output Button Mode

Switch SW3-3 configures the way the talkback output button functions.

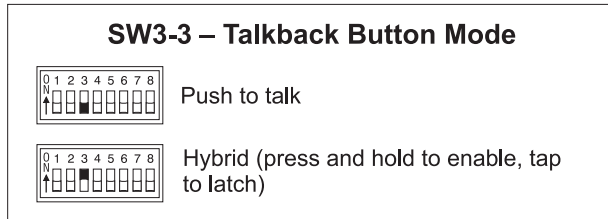

Figure 8. Talkback output button mode settings

Two modes are available:

- **Push to talk:** In this mode the talkback output is normally muted. The talkback output will become active whenever the button is pressed and held.
- **Hybrid:** This mode is a combination of push to talk and alternate action. If the button is pressed and held, the talkback output will become active until the button is released. If the button is momentarily “tapped” the talkback output will change state. Upon power up the talkback output will be in its muted state.

Headphone Output Operating Modes

The user is provided with two rotary level controls (“pots”) that are associated with the stereo headphone output. Switches SW3-4, SW3-5, and SW3-6 are used to configure the way the controls function. With just these three switches a wide range of operating modes can be configured. Carefully reviewing the capabilities of the available functions may prove worthwhile.

Dual-Channel or Stereo Mode

Switch SW3-4 is used to select whether the controls provide a dual-channel (“level/level”) or stereo (“level/balance”) mode of

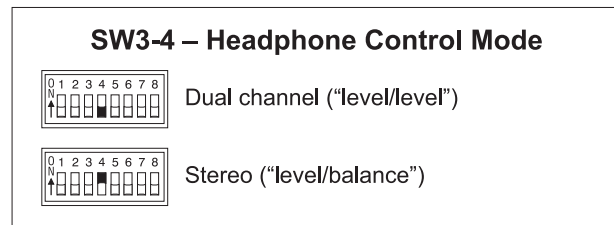

Figure 9. Headphone control mode settings

operation. In the level/level mode the two controls operate independently, each controlling the level of one of the headphone output channels. This mode is generally used for on-air broadcast applications where independent cue signals are provided to the left- and right-headphone channels. In the level/balance mode the left rotary control sets the overall output level for both headphone channels. The right rotary control is used to adjust the balance (the relative levels) of the left and right channels. This mode is generally best suited for applications where a stereo cue source is being provided.

Reverse Left/Right Mode

Switch SW3-5 is used to select whether the rotary controls are in the normal or reverse left/right mode of operation. When set to the normal mode, and level/level mode is also selected, the left control adjusts the level of headphone output’s left channel. (This is the signal that appears on the tip lead of the ¼-inch 3-conductor jack.) The right control adjusts the level of the right channel. When selected to the normal mode, and the level/balance mode is also selected, turning the balance control in the counterclockwise direction increases the perceived level of the left channel, and vice versa.

As you may have already guessed, when selecting the reverse left/right mode of operation everything is reversed! To be more specific, when selected for reverse mode,

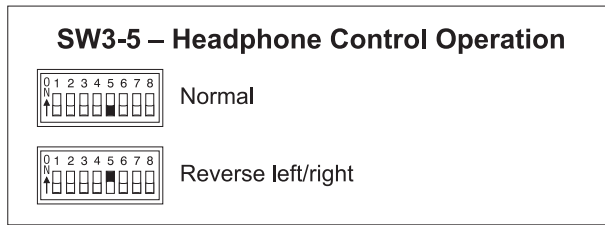

Figure 10. Headphone control operation settings

and the level/level mode is also selected, the left control adjusts the headphone output's right channel (output jack's ring lead) while the right control adjusts the left channel. When set to the reverse mode, and the level/balance is also selected, turning the balance control in the counterclockwise direction increases the perceived level of the right channel, and vice versa.

The reverse mode is provided specifically for cases where a headset's left and right earpieces are placed on a user's head in a reverse orientation. This ensures that the user is provided with a consistent and easy-to-use set of headphone level controls.

Minimum Level Mode

Switch SW3-6 is used to configure the headphone output's minimum level. In the -40 dB mode the minimum headphone output level is 40 dB below maximum. The headphone output channels will never fully mute. This ensures that any audio signal present on the selected Model 211 inputs will always be present on the headphone output. In most on-air broadcast applications this is the appropriate setting.

When the full mute mode is selected, and the level/level mode is also selected, moving either control to its fully counterclockwise position will cause its associated channel to fully mute.

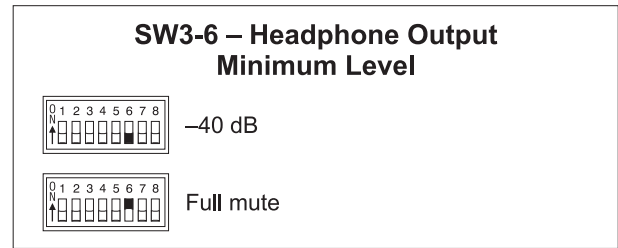

Figure 11. Headphone output minimum level settings

When the full mute mode is selected, and the level/balance mode is also selected, turning the level control to its fully counterclockwise position will cause both headphone channels to mute. Turning the balance control to either its fully clockwise or fully counterclockwise position will cause the appropriate channel to mute.

Selecting the full mute mode may be appropriate for applications where minimizing the chance of audio "leakage" is important. This could occur when the connected headset or headphones are at times placed on a desk or tabletop.

Main Output Source

Switch SW3-7 is used to select which audio source is routed to the main output. The choices are the output of the microphone preamplifier or the output of the compressor circuit. For most on-air applications the output of the microphone preamplifier is the desired source. This will provide the most natural audio quality with the potential for a large amount of dynamic range.

In some applications it may be desirable for the output of the compressor circuit to be routed to the main output. Appropriate applications could include on-air broadcast situations where non-professional talent is present. Controlling the dynamic range of the audio signals on the main output can limit the chance of cable crosstalk and

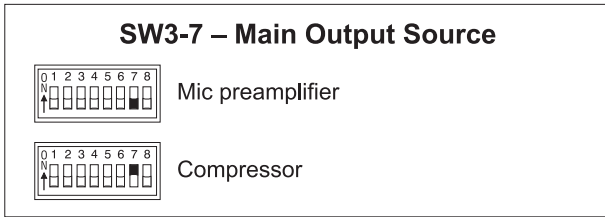

Figure 12. Main output source settings

equipment overload. Another typical application where using the output of the compressor would be when the Model 211's system mode is selected for production. In this case the main output would be used as an additional talkback output and dynamic range control could be beneficial.

System Mode

Switch SW3-8 is used to configure the overall operating mode of the Model 211. Specifically, it determines how the main output operates vis-à-vis the talkback output. Understanding how the two modes impact overall system operation will ensure that correct operation and maximum usability will occur. When selected to the on-air mode, the main output will mute whenever the talkback output is active. The on-air mode should be selected for all on-air broadcast applications. It's imperative that the main output be muted whenever on-air talent uses the talkback output to communicate with production personnel.

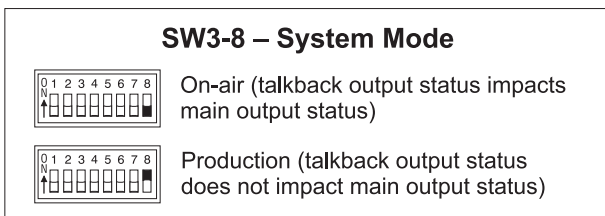

Figure 13. System mode settings

When the system mode is set for production, the main output is never muted in response to the talkback output being active. This mode allows the main output to be

used, for example, as an additional talkback output. In this way the main and talkback outputs can be used independently, with neither impacting the other. This also allows both buttons to be used simultaneously. When selected for the correct application, the production mode can prove to be very useful. But it's not appropriate for on-air use!

Adjusting the Line Input Trim Pots

As has been previously mentioned, associated with the two line inputs are trim pots that allow the input levels to be adjusted. The two trim pots are accessible by way of round openings in the bottom of the Model 211's enclosure. By adjusting these trim pots, signals with a nominal level of -12 dBV to $+6$ dBu can be effectively used as cue sources. Unfortunately, there are no definitive rules regarding how best to adjust the trim pots, but some suggestions may prove to be valuable. Depending on how the line inputs are utilized, the trim pots can be used to either adjust the absolute level of each line input signal or to adjust the relative level of the signals when compared to other sources. The following examples may provide some clarification.

Let's begin with an application that has a stereo cue source connected to the line inputs. The cue source selection switches are configured to create a stereo headphone output with line input 1 assigned to the left channel and line input 2 assigned to the right channel. Begin the trim pot adjustment process by moving the user level controls (located on the front panel) to their detent (50% of rotation) positions. Then, with the stereo cue source providing signal at its normal level, adjust the trim pots to provide a comfortable level to the connected headphones. The user can now, in response to

changing conditions, adjust the front-panel level controls as desired. Returning the controls to their detent positions will always provide the “reference” level to the headphone output.

A second example has line input 1, line input 2, and auxiliary input 1 all providing cue sources. Line input 1 might supply program-with-interrupt audio that is routed to the headphone output's left channel. Line input 2 might supply program-only audio that is routed to the right channel. And auxiliary input 1, interfaced using a line-input card kit, is connected to an audio source associated with a sports event “spotter” position. This source is routed to the headphone output's right channel. The input trim pot associated with line input 1 can now serve a critical role—adjusting the relative level of the “spotter” audio as compared to the level of line input 2. The trim pot allows the desired “mix” to be created, providing the user with an effective cue signal.

Conclusion

Once the switches have been set to the desired configuration and the line input controls adjusted as desired, the security plate should be reattached. The four rubber bumpers should be hand-tightened only. No tools should be used.

Operation

At this point the desired input, output, and power connections should have been made. The button labels may have been revised. Finally, the configuration switches should have been set and the line input trim pots adjusted as required. Normal operation of the Model 211 can now begin. The unit will begin functioning a few seconds after the 24 volt DC power source is connected.

Audio signals will not be present on the outputs if correct power has not been supplied. Specifically, the microphone does not passively “cut through” to the main output connector!

Upon Model 211 power up, the three status LEDs will light in succession as a firmware “boot up” indication. The unit will then begin normal operation. Depending on the selected configuration, one LED associated with the status of the main output may be lit. The user is now presented with two buttons, three LEDs, and two rotary controls. These are simple to operate and understand, as will be described in the following paragraphs.

Pushbutton Switches and Status LEDs

Two pushbutton switches are used to control the main and talkback outputs. The way each operates depends on the selected configuration. Three LED indicators are located adjacent to the buttons. They reflect the status of the main and talkback output functions.

Main Output Button and LED Indicators

The button on the left, factory labeled as COUGH, functions according to the selected configuration. Two LED indicators, located directly above the button, are associated with the status of the main output. The green LED, located on the right, is lit whenever the main output is active. This could be considered as an “on-air” or mic active indicator. At the least it should serve as a “careful what you say” warning! If the Model 211's system mode is configured to on-air, the red LED, located on the left, will be lit when the main output is muted. This indicates that it's safe to speak as one sees fit.

If the Model 211's system mode is configured to production, the red LED will never light. This is to reflect the fact that the main output button has now taken on a function similar to that of the talkback output button. To clarify, when the Model 211 is set to the production mode, the red LED will never light; the green LED will light whenever the main output is active.

Main Output Button Modes

- **Push to mute:** If this mode is selected the main output is normally active. The main output will mute whenever the button is pressed and held.
- **Push to talk:** If this mode is selected the main output is normally muted. The main output will become active whenever the button is pressed and held.
- **Alternate action:** If this mode is selected the main output will alternate between its active and muted states whenever the button is pressed. Upon power up the main output will be in its muted state.
- **Hybrid:** This mode is a combination of push to talk and alternate action. It's similar to the way talk buttons function on user stations associated with broadcast or production intercom systems. If the button is pressed and held, the main output will become active until the button is released. If the button is momentarily "tapped" the main output will change state. Upon Model 211 power up the main output will be in its muted state.

Main Output vis-à-vis Talkback Activity

This short section applies only in the case where the Model 211's system mode is configured for on-air and the main output button mode is set to alternate action or hybrid.

Talkback activity will always cause the main output to be placed in its off state. If the main output was in the "latched" on state when talkback began, once talkback activity ends that state will resume; the main output will again be in its on ("latched") state.

Talkback Output Button and LED Indicator

The button on the right, factory labeled TALKBACK, controls the talkback output. The manner in which the talkback button functions depends on the way it was configured. One LED indicator, green in color, is located directly above the talkback button. It lights whenever the talkback output is active. If the Model 211's system mode is selected to on-air, whenever the talkback function is active the main output will be placed in the muted state. If the Model 211 is selected to the production mode, the status of the talkback output will not impact the main output.

Talkback Output Button Modes

- **Push to talk:** If this mode is selected the talkback output is normally muted. The talkback output will become active whenever the button is pressed and held.
- **Hybrid:** This mode is a combination of push to talk and alternate action. If the button is pressed and held, the talkback output will become active until the button is released. If the button is momentarily "tapped" the talkback output will change state. Upon Model 211 power up the talkback output is will be in its muted state.

Headphone Output Level Controls

Two rotary controls (“pots”) are located on the Model 211’s front panel and are associated with the headphone output. The way the controls function depends on the selected configuration. One configuration parameter sets the controls to operate in a level/level or a level/balance mode. Another parameter allows the left/right assignment of the controls to be reversed. A third parameter selects whether the headphone output channels will maintain a minimum output level or can be fully muted.

Level/Level Mode

When set to the level/level mode, the two controls operate independently. Each control sets the output level of one channel of the stereo headphone output. If configured to the normal mode, the control on the left side is used to adjust the level of the headphone output’s left channel. The control on the right is used to adjust the level of the right channel. If configured to the reverse left/right mode, the control on the left side adjusts the headphone output’s right channel. The control on the right adjusts the left channel.

When in the level/level mode, and the minimum output level is set for –40 dB, turning each control to its fully counterclockwise position will place its respective output level 40 dB below its maximum. This setting ensures that talent will never be fully “isolated” from potentially important cue signals. If present on the Model 211’s input and assigned to the headphone channels, some audio signal will always be present on the headphone output. If set to the full mute mode, turning each control to its fully counterclockwise position will cause its respective output to fully mute.

Each level control has a mechanical step (detent) that is located at the halfway (50%) position of its rotation range. This is intended to serve as an aid to Model 211 users. In an ideal installation, setting the controls to their detent position will result in a comfortable headphone output level. The user, in response to a changing operating environment, can then move the level controls to get more or less level as desired. The detent position will always remain as a useful reference point. To achieve this condition the audio level on the connected IFB circuit, or line input, will have to be calibrated as required. This is somewhat counter to the usual mentality of just providing the user with whatever level comes up by default. Spending a few extra minutes “trimming” the audio levels can result in much happier, and more productive, talent.

Level/Balance Mode

When set to the level/balance mode, the two controls operate together to adjust the desired headphone output level. The control on the left adjusts the overall level of both the left and right channels. The balance control, located on the right, adjusts the relative left/right level balance. In this mode the controls operate in a manner reminiscent of a consumer audio amplifier or receiver. If set to the normal mode, rotating the balance control in the counterclockwise direction reduces the level of the right channel providing the user with more perceived level in the left channel. If set to the reverse mode, rotating the balance control in the counterclockwise direction reduces the level of the left channel providing the user with more perceived level in the right channel.

When in the level/balance mode and the minimum output level is set to -40 dB, turning the level control to its fully counterclockwise position will place both headphone output channels to 40 dB below maximum. This ensures that talent will never be fully “isolated” from potentially important cue signals. In addition, rotating the balance control to either its fully clockwise or fully counterclockwise position will cause the applicable channel to be 40 dB below its maximum. If set to the full mute mode, turning the level control to its fully counterclockwise position will cause both the left and right channels to fully mute. In addition, rotating the balance control to either its fully clockwise or fully counterclockwise position will cause the applicable channel to fully mute.

Each control has a mechanical step (detent) that is located at the halfway (50%) position of its rotation range. The balance control will typically be set to its center, detent position, making the level of the left and right channels equal. In an ideal installation, the level control can also be set to its detent position and provide a comfortable headphone output level. This will allow the user, in response to their preference or a changing environment, to adjust the level and balance controls as desired. The detent positions will always remain as a useful reference point. To achieve this condition the audio level on the connected IFB circuit, or line input, must be adjusted as required. Spending a few extra minutes “trimming” the connected audio levels, rather than just providing whatever happens to come up, should prove worth-while. The result will be talent that is more relaxed, and an overall production that works more smoothly.

Technical Notes

Grounding and Shielding

As previously discussed in this user guide, the pin 1 connections on both the main and talkback outputs’ 3-pin male XLR connectors are “floating,” i.e., not connected to anything within the Model 211’s enclosure. Some audio experts might take offense to this, complaining that this should have been left to the user or installer to be connected or disconnect as desired. However, repeated field testing found that floating pin 1 on the outputs was the key to maintaining quiet audio. From Fenway Park, to the Orange Bowl, and then northwest to Husker Stadium, lifting pin 1 did the trick.

A simple solution is available if an application does require that a ground be available on the main and talkback outputs’ interconnecting cables. All Model 211 XLR connectors have a ground connection that is made to the interfacing connector’s metal “shell.” And most XLR connectors have a pin or connection point available to access its metal shell. By connecting the cable shield to the mating connector’s shell terminal, the common connection typically found on audio interconnections is created.

Phantom Power

The Model 211 provides a 48 volt nominal source of phantom power to support condenser-type microphones. It’s designed to meet the P48 requirements as specified in the IEC 61938 standard. The circuitry is very simple: 6.85 k ohm resistors provide a path from a 45 volt source to pins 2 and 3 of the microphone input connector. The resistors and the power source work together to provide 48 ± 4 volts, up to a maximum current of 10 milliamperes.

Symptoms of Insufficient Power

A core part of the Model 211's internal circuitry is a switch-mode power supply that produces +45 volts, +12 volts, +5 volts, and -12 volts. This power supply circuit works very well as long as it is "fed" with sufficient input voltage and current. "Sufficient" is defined as a minimum of 20 volts and 70 milliamperes.

It's worth discussing what will happen if the power source falls below its specified minimum. Normal operation will continue until the source falls to somewhere in the range of 18-20 volts. As the voltage drops below this range the Model 211's internal power supply will have reduced stability, operating in this manner until its low-voltage shutdown circuit halts operation. Note also that as the input voltage moves down from 24 volts the input current will rise proportionately to make up for the loss of power.

Travel Case

For portable applications it may be desirable to store and transport each Model 211 in a protective case. After much travel with prototype announcer console units, Studio Technologies' personnel learned to appreciate the Pelican Model 1450 case. Purchased with the foam interior option, it does an excellent job of holding one Model 211 and its associated 24 volt DC power supply. Some applications may benefit from selecting a larger case that would also hold a related headset, cables, etc. A larger case could also be selected that would hold multiple Model 211 units. Pelican sells their products through a dealer network, many of which can be located via a web search.

IFB Input Card Kit

The Model 211 is designed to directly connect with line-level cue signals, also sometimes referred to as "dry" broadcast IFB circuits. However, there may be applications where it would be helpful to also be able to connect to a powered ("wet") IFB or party-line (PL) intercom circuit. In this case the Studio Technologies IFB Input Card Kit (order code 31212) can be installed.

The IFB input card kit contains a printed circuit board assembly with 3-pin female XLR connector, an interconnecting cable, and hardware. To install the kit is very simple. The XLR connector is mounted into one of the spare connector locations on the Model 211's back panel. This secures the connector and associated printed circuit board to the enclosure. The interconnecting cable is then used to link the card and the Model 211's main printed circuit board assembly. One end of the cable is plugged into the IFB input card's 3-position header that is labeled OUT 1/2. The other end of the cable is plugged into the 3-position header connector that is labeled AUX IN 1/2. This is located on the main printed circuit board.

Several things are worth mentioning when it comes time to actually using the IFB input card. The two input channels are transformer coupled with a nominal input of -10 dBu and a nominal input impedance of 10 k ohms. Capacitors in series with the transformers' primary windings provide isolation and protection from any DC voltage present on the connected IFB or party-line intercom circuit. It's important to note that DC power present on either or both pins of the powered IFB input connector cannot be used to power the Model 211. An external source of 24 volts DC must always be connected.

Note that if an IFB input card is installed in a Model 211, the audio sources associated with the line-inputs and the powered (“wet”) IFB circuit can be connected at the same time. The audio sources will be routed to the headphone outputs by way of the headphone source configuration switches. Each of the four possible audio sources can be routed to the left-headphone output, the right-headphone output, or both headphone-output channels. Details on how to use these switches are provided in the Configuration section of this user guide.

Additional Connector Locations

Two spare connector locations are provided on the Model 211’s back panel. They are labeled A and B. From the factory they contain blank plates that can be readily removed and replaced with a variety of “XLR style” connectors. The spare connector locations are specifically included so that a Model 211 can be customized to meet the many specific needs that arise in broadcast and related audio applications. Expected uses for these locations include adding a 6- or 7-pin XLR connector to allow direct connection of a broadcast headset. Other uses include creating a “loop through” or “mult” function for the microphone input or headphone output connections. A number of interface cable assemblies, along with some special function kits, are available from Studio Technologies. Please refer to the website for details on what is available.

The spare connector locations are compatible with the Neutrik DL-series of connectors. For flexibility, XLR versions are available that provide from three to seven contacts. For example, a compatible 3-pin

female connector would be Neutrik part number NC3FD-L-1. The NC6FDS-L-1 is often used to support headsets. This is a 6-pin female connector with the unique Switchcraft® 6-pin arrangement. Other connectors, such as the etherCON protected RJ45 and 3-conductor ¼-inch jack, can also be installed. The 4-40 thread-pitch hardware that secures the blank plates to the Model 211’s back panel are also intended to secure the replacement connectors.

If connectors are added to the Model 211’s spare connector locations adding labels to those connectors can be helpful. For a great look it is recommended that Brother® P-Touch ¼-inch (6 mm) labels be created. Tape material that prints white text on a black background works out well for the Model 211. The Brother label cassette number TX-3151, white on black, is appropriate for use with many of their printers.

3-Position Headers

In addition to the spare connector locations on the back panel, provision has been made to allow easy interconnection with the Model 211’s printed-circuit-board-mounted input and output connectors. This was accomplished by including several 3- position male header connectors on the Model 211’s circuit board. These headers, on 0.1-inch centers, are wired in parallel with some of the Model 211’s connectors. This “no solder” solution makes customizing a Model 211 a simple process. The headers, located on the Model 211’s printed circuit board, are Molex® part number 22-23-2031. They mate with Molex housing number 22-01-3037.

To make the interconnection, separate crimp terminals are attached to three loose wires and then “snapped” into the housing.

Molex part number 08-50-0114 specifies crimp terminals that are appropriate for 22 to 30 gauge wires. These terminals are available worldwide from sources such as Digi-Key (www.digikey.com).

To make the process of connecting to the Model 211's headers a simple task an interface cable kit, order code 31087, is available from Studio Technologies. Each kit includes five cable assemblies and a length of heat-shrinkable tubing. Each cable assembly consists of a mating connector with three color-coded wires attached. These wires, approximately 12 inches in length, allow convenient soldering to a connector selected to be installed in a spare location on the Model 211's back panel. For reference, the wire color for pin 1 is gray, pin 2 is yellow, and pin 3 is blue.

The heat-shrinkable tubing is provided so that the connector terminals or "solder cups" can be insulated from each other. It will also provide some strain relief to the solder joints. Be certain to slip the desired length of tubing over the wire prior to soldering a connection! (If the writer had a dollar for every time he forgot to put tubing on a wire (or slip on a connector shell) before making a solder connection...)

Most of the 3-position headers on the Model 211's main circuit board assembly are located close to their related input or output connectors. Other headers provide access to functions such as the relays or the remote control inputs. For details on the headers please refer to Appendix B at the end of this guide.

Remote Control Connections

Provision has been made on the Model 211's printed circuit board assembly to allow external switches or contact closures

to control the status of the audio signal sent to the main and talkback outputs. Two 3-position headers provide access to the circuitry associated with the functions. Refer to Appendix B for connection details. The input circuitry is "active low," with a 10 k ohm resistor connected to +5 volts DC to act as a pull up. A combination of resistors and capacitors provide ESD protection.

Relay Contacts

The Model 211 provides two normally open (not shorted) relay contacts for use in specialized applications. One is associated with the main output and the other with the talkback output. Whenever audio is being sent to the main output relay contact 1 will close (short). And whenever audio is being sent to the talkback output relay contact 2 will close (short). The two relays operate under software control and are always active, whether or not connections are made to them. Some "head scratching" or "brainstorming" should lead to a number of interesting ways to take advantage of the relay contacts. Applications could include keying wireless transmitters, activating "on-air" lights, and muting loudspeaker systems. To utilize the relay contacts does require the talents of a qualified technician. This is because the Model 211's enclosure must be disassembled and the desired wiring scheme implemented. For detailed information on interfacing with the relay contacts refer to Appendix B at the end of this guide.

Pushbutton Backlighting

For special applications, provision has been made to allow LED illumination ("backlighting") of the two pushbutton switches. This may prove useful for applications where adequate room lighting is not available. It can also serve in custom Model 211 configurations. It's important to note that the button

lighting is not intended to serve tally applications. It is strictly intended to provide a moderate amount of illumination of the button's clear lens and associated labeling.

From the factory, LED lamps are not installed in the pushbutton housings. The housing of each pushbutton was designed for inserting a pluggable T-1 bi-pin incandescent type but more modern leaded T1 LEDs work very well. The Model 211's 5 volt DC power supply is connected to the socket in each pushbutton housing by way of 2.2 k (2200 ohm) resistors. With this implementation, along with the recommended LED, only 1 milliampere per LED is consumed.

It's intended that high-efficiency white LEDs be installed. They use very little DC current and have essentially infinite life. The recommended LED is the Kingbright WP7104QWC/D which, as of the time of this writing, is available from sources such as Digi-Key (www.digikey.com) and Mouser Electronics (www.mouser.com).

The mating socket in each pushbutton assembly is accessed by removing the button's lens cap, graphic label, and back frosted lens. Once this is done installing the LED should be very simple, requiring only lead trimming and careful insertion. Begin by removing the top clear lens, label, and frosted under-lens in each pushbutton. Trim the LED leads to 0.25 inches (6.4 mm) in length and insert into the sockets with the cathode end located nearest the front of the Model 211. Power up the Model 211 and observe if the LEDs light. They are polarity sensitive and if either or both do not, remove the offending LED(s), rotate them 180 degrees, and then re-insert.

Compressor Circuit

In this section some general information about the Model 211's compressor circuit will be provided. As previously discussed, the output of the microphone preamplifier circuit is connected to a studio-quality compressor circuit. The output of the compressor is used by the talkback output and, if configured, the main output. (In most cases the main output will utilize the signal coming directly out of the microphone preamplifier.) The gain element in the compressor circuit is a laser-trimmed voltage-controlled-amplifier integrated circuit. It provides accurate, low-noise, low-distortion performance. The threshold of the compressor circuit is 2 dB above the Model 211's nominal internal operating level of -2 dBu. A 5:1 compression ratio is implemented and, like the threshold level, is not field adjustable. The threshold and ratio settings were selected so that excellent talkback audio would be provided. By controlling the dynamic range, intelligibility can be improved and overloading of connected devices can be avoided. An LED indicator lights whenever the compressor's threshold has been reached and the circuit is actively controlling the dynamic range. This LED is provided as an aid when setting the gain of the microphone preamplifier.

Specifications

General Audio:

Frequency Response: 10 Hz-20 kHz, ± 0.2 dB, mic in/main out

Distortion (THD+N): 0.008%, measured at 1 kHz, mic in/main out

S/N Ratio: 86 dB, referenced to -42 dBu mic in/
 -2 dBu main out

Dynamic Range (A-weighted): 108 dB

Connectors:

Mic In, Line In 1 & 2: 3-pin female XLR

Main Out, Talkback Out: 3-pin male XLR

Headphone Out: $\frac{1}{4}$ -inch 3-conductor phone jack

24 Vdc Power In: coaxial power jack, 2.1 x 5.5 mm, locking bushing, compatible with Switchcraft S760K plug

Spare Connector Locations: 2

Allows one or two Neutrik NC*D-L-1 connectors to be installed (*=3F, 3M, 5F, 5M, 6F, 6FS, etc.)

Microphone Input/Preamplifier:

Type: electronically balanced

Input Impedance: 2 k ohms, nominal

CMRR: >80 dB, 20 Hz-20 kHz, 40 dB gain

Gain Range: 20 to 60 dB, nominal, adjustable in 10 dB steps; 0 dB (no gain) also available

Compatibility: dynamic or phantom-powered mics

Phantom Power: 45 volts DC nominal, meets IEC 61938 P48 standard

Line Inputs: 2

Type: balanced, transformer-coupled

Impedance: 10 k ohms

Nominal Level: -12 dBV to $+6$ dBu, adjustable

2-Channel Auxiliary Input:

Implementation: optional IFB Input Card Kit (Studio Technologies order code 31212) can be installed into back panel

Type: 2-channel, unbalanced, transformer-coupled

Impedance: 10 k ohms, nominal

Nominal Level: -10 dBu

Compressor:

Threshold: 2 dB above nominal level

Attack/Release Time: 2 mSec/100 mSec, nominal

Slope: 5:1, nominal

Status LED: compressor active

Main Output:

Type: balanced, transformer-coupled

Nominal Level: -2 dBu

Maximum Level: $+20$ dBu into 2 k ohms

Impedance: 100 ohms, nominal

Source: output of microphone preamplifier or output of compressor, selectable

Talkback Output:

Type: transformer-coupled with series capacitors and isolation resistors

Impedance: 600 ohms, nominal

Nominal Level: $+4$ dBu

Maximum Level: $+11$ dBu (compressor restricts maximum)

Headphone Output: 1, stereo

Compatibility: intended for connection to mono or stereo headphones or headsets with nominal impedance of 100 ohms or greater

Type: voltage driver

Maximum Output Voltage: 12 Vpp, 150 ohm load

Relay Contacts: 2

Functions: follows status of main and talkback outputs

Type: form-A (normally open, not-shorted) solid-state relay contact

Rating: 100 mA, 60 volts AC/DC, maximum

Contact Resistance: 16 ohms, maximum

Access: requires user-implemented connection method

Power Source: 24 volts DC nominal, 70 mA @ 24 volts DC; acceptable range 20-30 volts DC. Each unit shipped with a universal input/24 volt DC output power supply.

Dimensions (Overall):

5.6 inches wide (14.2 cm)

3.3 inches high (8.4 cm)

8.5 inches deep (22.4 cm)

Weight: 3.4 pounds (1.6 kg)

Specifications and information contained in this User Guide subject to change without notice.

Appendix A

Attached to the bottom of the unit is a security plate with text that provides a summary of the configurable parameters and related information.

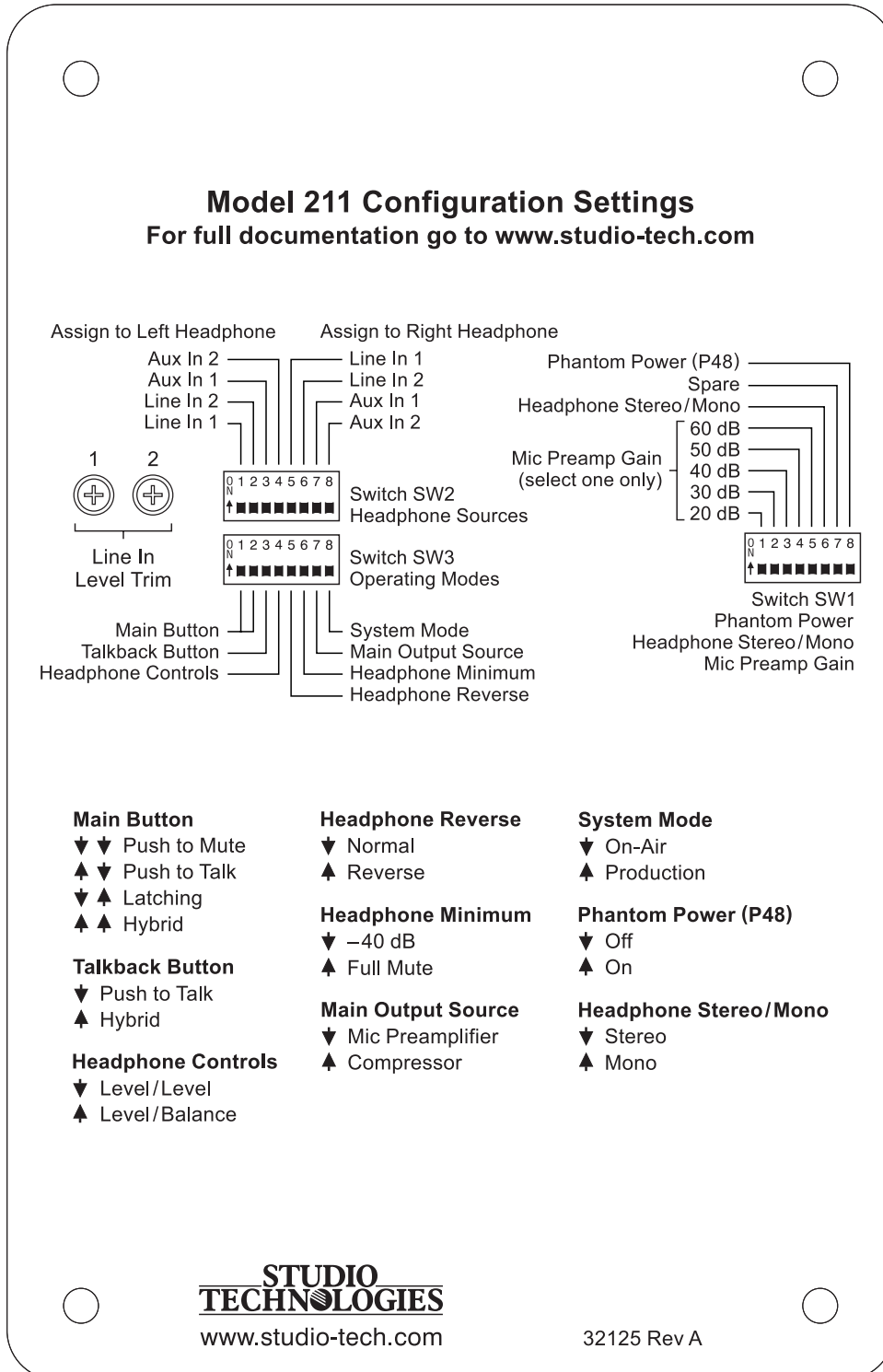

Appendix B

The following list provides details on the 3-pin header connectors located on the Model 211's printed circuit board. Shown are reference numbers, reference text, and function descriptions.

P3 PHONES: Headphone Output

Pin 1 common
Pin 2 tip (left)
Pin 3 ring (right)

P4 MIC IN: Microphone Input

Pin 1 shield
Pin 2 high
Pin 3 low
(Follows back-panel 3-pin female XLR pin assignment)

P5 MAIN OUT: Main Output

Pin 1 shield
Pin 2 high
Pin 3 low
Careful! Back-panel 3-pin male XLR has pin 1 floating, pin 2 high, pin 3 low

P6 TALKBACK OUT: Talkback Output

Pin 1 shield
Pin 2 high
Pin 3 low
Careful! Back-panel 3-pin male XLR has pin 1 floating, pin 2 high, pin 3 low

P7 LINE IN 1: Line Input 1

Pin 1 common
Pin 2 high
Pin 3 low

P8 LINE IN 2: Line Input 2

Pin 1 common
Pin 2 high
Pin 3 low

P9 DC IN 1: 24 Volt DC Input (used by Model 211's back-panel connector)

Pin 1 common
Pin 2 +24 Vdc
Pin 3 not used

P10 DC IN 2: 24 Volt DC Input

Pin 1 common
Pin 2 +24 Vdc
Pin 3 not used

P11 AUX IN CH 1/2: Auxiliary Audio Inputs

Pin 1 common
Pin 2 channel 1 unbalanced audio @ -10 dBu nominal
Pin 3 channel 2 unbalanced audio @ -10 dBu

P12 RELAY OUTS MAIN: Form-A (normally open, not-shorted) Solid-State Relay Contact

Pin 1 common
Pins 2 & 3 relay contact (isolated from common)

P13 RELAY OUTS TALKBACK: Form-A (normally open, not-shorted) Solid-State Relay Contact

Pin 1 common
Pins 2 & 3 relay contact (isolated from common)

P16 DC OUT 1: Auxiliary DC Output 1

Pin 1 common
Pin 2 +12 Vdc
Pin 3 -12 Vdc

P17 DC OUT 2: Auxiliary DC Output 2

Pin 1 common
Pin 2 +12 Vdc
Pin 3 -12 Vdc

P18 SW INS: Remote Switch Inputs

Pin 1 common
Pin 2 main output control
Pin 3 talkback output control

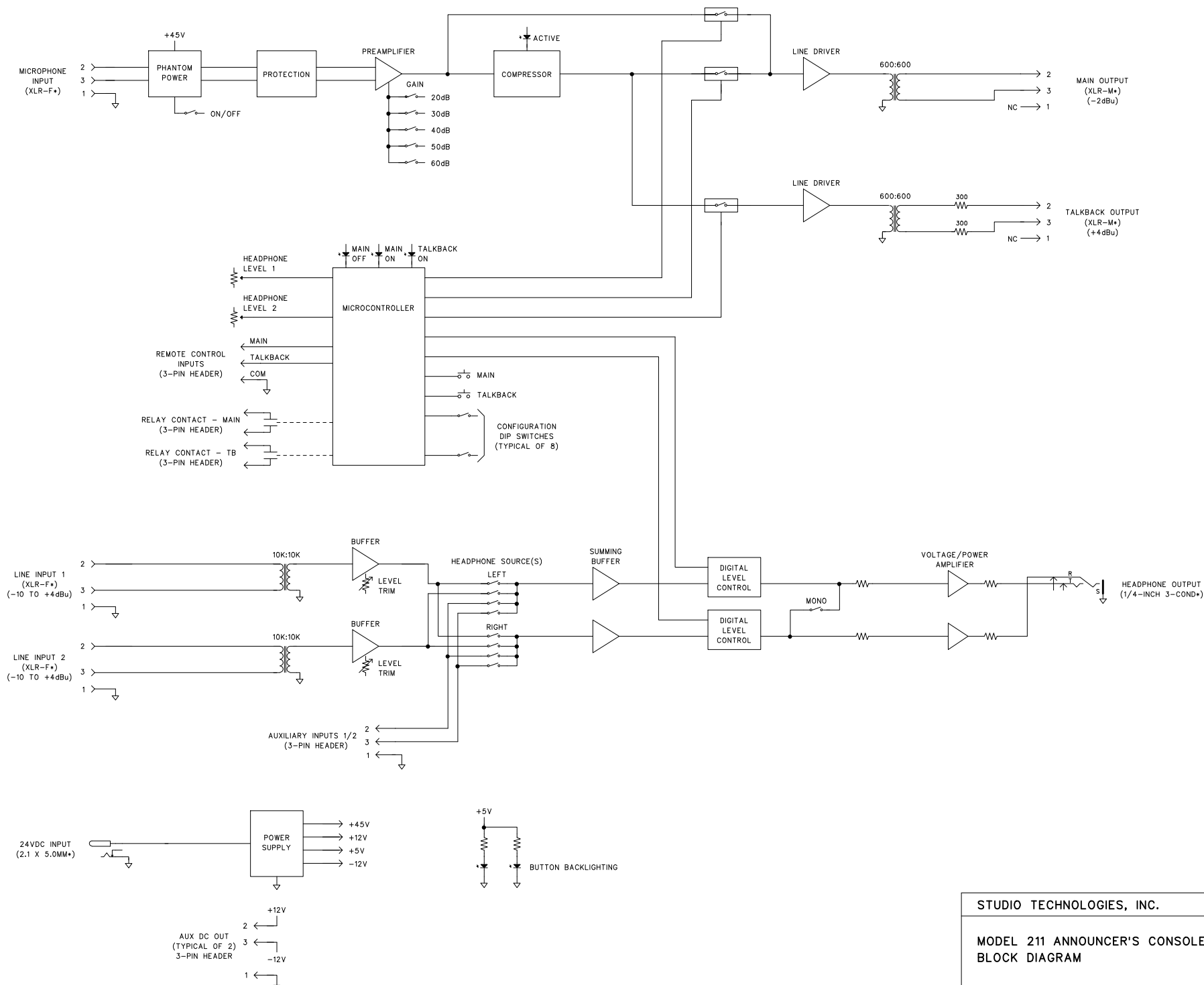

M211BD_A

STUDIO TECHNOLOGIES, INC.

MODEL 211 ANNOUNCER'S CONSOLE
BLOCK DIAGRAM

* ALSO HAS 3-PIN HEADER IN PARALLEL ON PRINTED CIRCUIT BOARD

DRAWING NO.	DATE	PAGE
32094	12/17/15	01 OF 01

